

126 series miniature hexagonal connectors

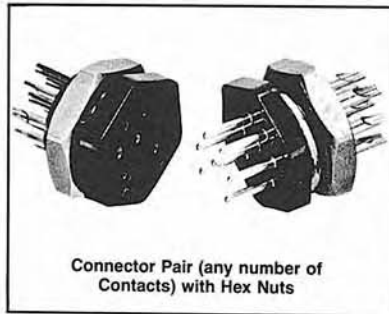

4 Contact Connector with Hood and Locking Clip #2



Connector Pair (any number of Contacts) with Hex Nuts

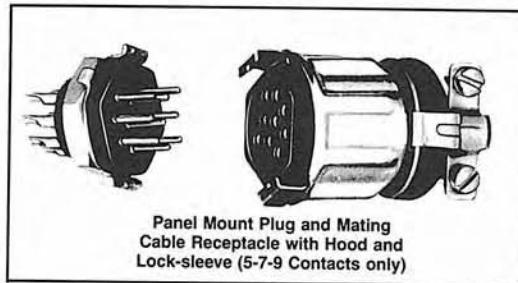

Panel Mount Plug and Mating Cable Receptacle with Hood and Lock-sleeve (5-7-9 Contacts only)

WPI miniature hexagonal connectors are available in four contact configurations with a variety of accessories to meet a wide range of applications.

The connectors can be used for rack and panel, cable to cable, and cable to panel connections.

Locking clips are available to prevent unmating caused by vibration or shock.

Dimensions

Overall Diameter – $\frac{3}{4}$ "

Mated – $1\frac{15}{64}$ " (extended length to the back of the cable clamp)

Specifications

Dielectric — thermoplastic

Contact size — #20 (except one #16 on 4 contact insert)

Wire size — #20 or smaller

Temperature range — -60°C to $+125^{\circ}\text{C}$ (-76°F to $+257^{\circ}\text{F}$)

Current rating — 7.5 amps

Voltage rating — 500 VAC (RMS) at Sea Level

Hardware — cold rolled steel, nickel plated

Contacts - copper alloy, gold over nickel plate

Panel thickness — $\frac{3}{32}$ " (max)

Mounting Holes

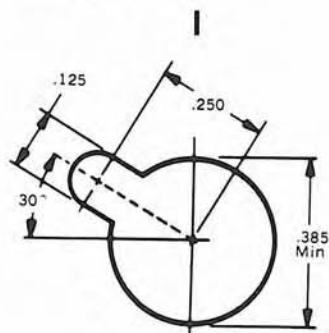

Four-Contact
126-214, 126-214-1001,
126-233, 126-215-1002 only

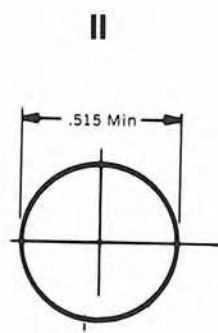

5-7-9 Contact
Hex Nut Type Without
Panel Locking Clip

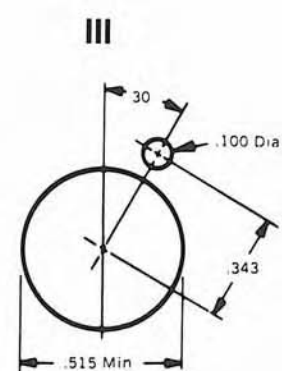

5-7-9 Contact
Hex Nut Type With
Panel Locking Clip

Design specifications subject to change. Consult WPI for the latest specifications.

126 series connector assemblies

4-Contact

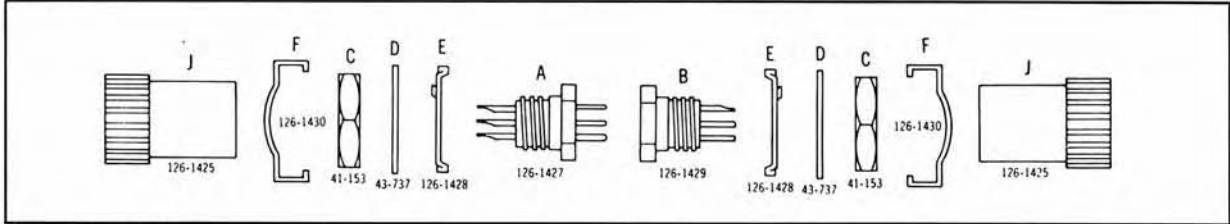

5-7-9 Contact Connectors

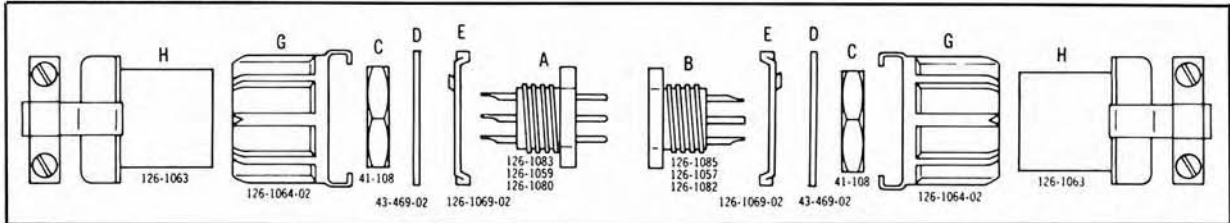

order information

These connectors can be ordered in any combination to suit your needs. Please refer to the exploded view drawing above to determine the components you require. Note the identification letter. Then order by the WPI part

number indicated along side the desired combination of components and the required number of contacts. For example, a male 5 contact connector with rear hood & cable clamp and lock sleeve requires components A, G and H. In the column for male 5 contact

assemblies, AGH indicates part number 126-217. If you order part #126-217, you will automatically receive all three components. They may also be ordered individually, if you prefer. Simply refer to the individual component part numbers shown below.

connector assemblies

4-Contact

Key	MALE Part No.	Mtg.	Key	FEMALE Part No.	Mtg.
A	126-1427	—	B	126-1429	—
AC	126-1431 *	—	BC	126-3815 *	—
ACD	126-1432 *	—	BCD	126-3816 *	—
AFJ	126-214-1000	—	BFJ	126-215	—
ACE	126-214	I	BCE	126-233	I
ACDE	126-214-1001 *	I	BCDE	126-215-1002 *	I
AEJ	126-214-1002 *	—	BEJ	126-215-1001 *	—

Backshells do not have cable clamps.

5-Contact

Key	MALE Part No.	Mtg.	Key	FEMALE Part No.	Mtg.
A	126-1083	—	B	126-1085	—
AC	126-010	II	BC	126-011	II
ACD	126-010-1000 *	II	BCD	126-011-1000 *	II
AGH	126-217	—	BGH	126-223	—
ACE	126-216	III	BCE	126-218	III
ACDE	126-216-1000 *	III	BCDE	126-218-1000 *	III
AEH	126-217-1000 *	—	BEH	126-223-1000 *	—

*Non-stocking item — Consult factory for delivery.

126 series connector assemblies (cont.)

parts

4-Contact Connector

Description	Part No.	Item Key
Basic Male Connector	126-1427	A
Basic Female Connector	126-1429	B
Hex Nut	41-153	C
Lockwasher	43-737	D
Clip #1	126-1428	E
Clip #2	126-1430	F
Hood	126-1425	J

7-Contact

Key	MALE Part No.	Mtg.	Key	FEMALE Part No.	Mtg.
A	126-1059	—	B	126-1057	—
AC	126-191	II	BC	126-192	II
ACD	126-191-1000 *	II	BCD	126-192-1001 *	II
AGH	126-195	—	BGH	126-196	—
ACE	126-197	III	BCE	126-198	III
ACDE	126-197-1000 *	III	BCDE	126-198-1003 *	III
AEH	126-195-1002 *	—	BEH	126-196-1000 *	—

9-Contact

Key	MALE Part No.	Mtg.	Key	FEMALE Part No.	Mtg.
A	126-1080	—	B	126-1082	—
AC	126-012	II	BC	126-013	II
ACD	126-012-1000 *	II	BCD	126-013-1000 *	II
AGH	126-220	—	BGH	126-222	—
ACE	126-219	III	BCE	126-221	III
ACDE	126-219-1000 *	III	BCDE	126-221-1000 *	III
AEH	126-220-1000 *	—	BEH	126-221-1001 *	—

5-7-9-Contact Connectors

Description	Part No.	Item Key
5-contact Basic Male Connector	126-1083	A
5-contact Basic Female Connector	126-1085	B
7-contact Basic Male Connector	126-1059	A
7-contact Basic Female Connector	126-1057	B
9-contact Basic Male Connector	126-1080	A
9-contact Basic Female Connector	126-1082	B
Hex Nut	41-108	C
Lock washer	43-469-02	D
Clip	126-1069-02	E
Locksleeve	126-1064-02	G
Hood & Cable Clamp	126-1063	H

*Non-stocking item — Consult factory for delivery.